

Zwischenträger
 Intermediate bracket

270

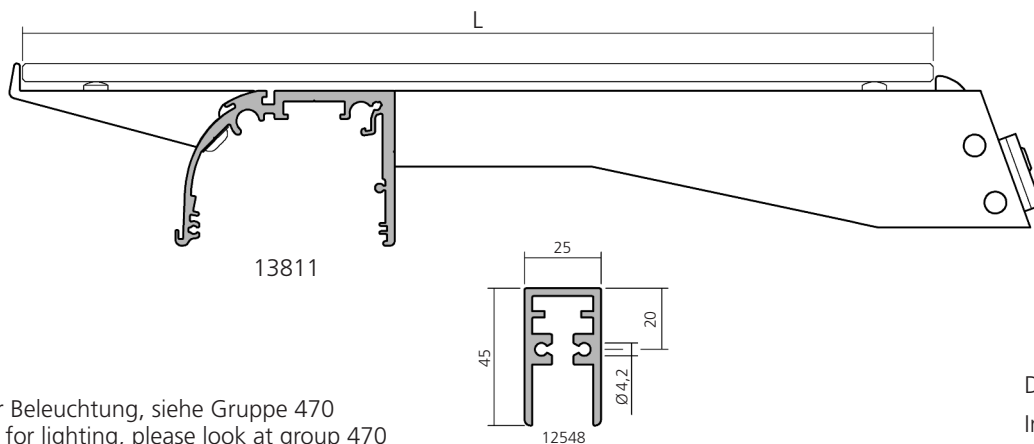
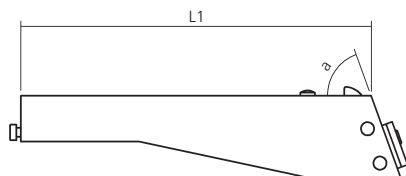

 Zubehör für Beleuchtung, siehe Gruppe 470
 Accessories for lighting, please look at group 470

 Darstellung
 Image **40%**

 Zwischenträger, Aluminium
 Intermediate bracket

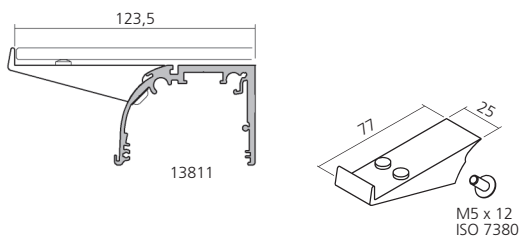
 a 60°
 L 300 / L1 193 **24013**
 L 350 / L1 243 **24014**

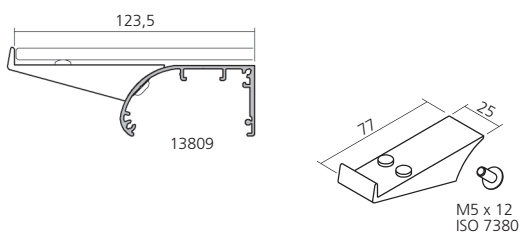
 a 70°
 L 300 / L1 193 **24011**
 L 350 / L1 243 **24012**

 nach Angabe
 on indication **24015**

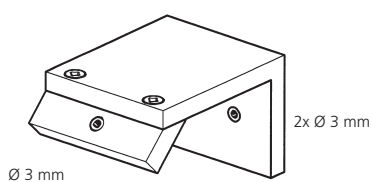
 Vorsatzträger, Aluminium
 Preset bracket

23876

 Vorsatzträger, Aluminium
 Preset bracket

23897

 Bohrschablone, Aluminium
 Drilling jig

23878

 passend für Beleuchtungsblende 13811 / 13809
 compatible for light shield 13811 / 13809

Zwischenträger
 Intermediate bracket

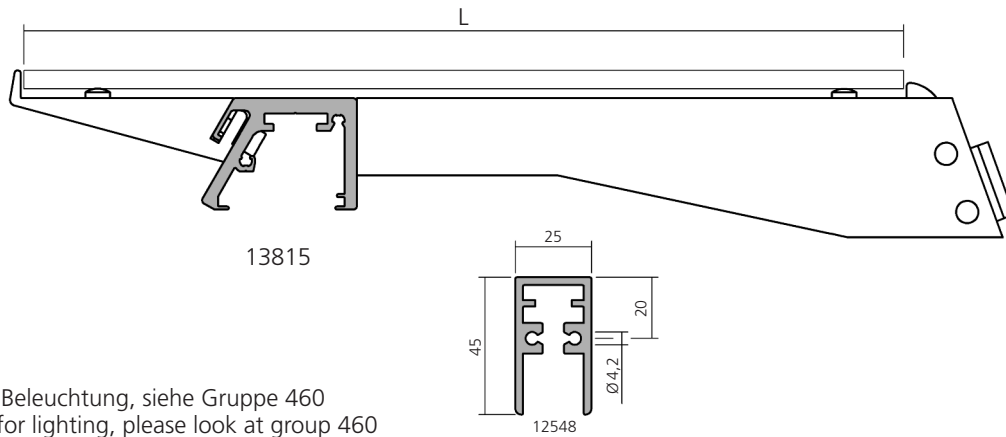
270

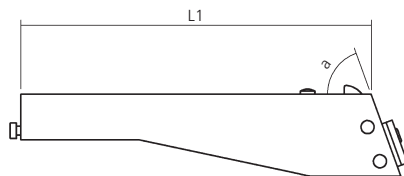

 Zubehör für Beleuchtung, siehe Gruppe 460
 Accessories for lighting, please look at group 460

 Darstellung
 Image **40%**

 Zwischenträger, Aluminium
 Intermediate bracket

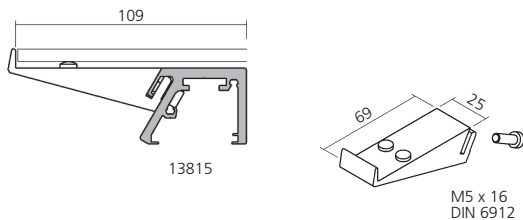
 a 60°
 L 300 / L1 208 **24023**
 L 350 / L1 258 **24024**

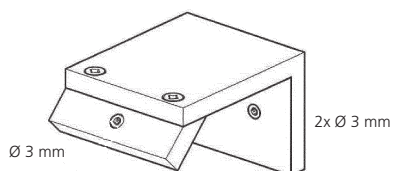
 a 70°
 L 300 / L1 208 **24021**
 L 350 / L1 258 **24022**

 nach Angabe
 on indication **24025**

 Vorsatzträger, Aluminium
 Preset bracket

23951

 Bohrschablone, Aluminium
 Drilling jig

23493

 passend für Beleuchtungsblende 13815
 compatible for light shield 13815

Zwischenträger
 Intermediate bracket

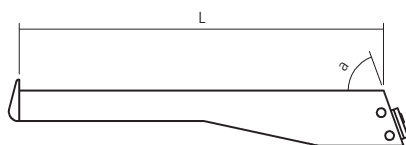
270

 Zwischenträger, Aluminium
 komplett montiert

a 60°	
L 300 mm	21348
L 350 mm	21381
L 400 mm	21384
L 450 mm	21387

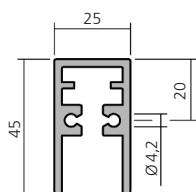
 Intermediate bracket
 completely assembled

a 70°	
L 300 mm	21347
L 350 mm	21380
L 400 mm	21383
L 450 mm	21386

 a nach Angabe
 a on indication

L 300 mm	21349
L 350 mm	21382
L 400 mm	21385
L 450 mm	21388

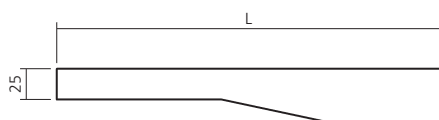
 Zwischenträger, Aluminium
 ohne Neigung

L 300 mm	21350
L 400 mm	21351
L 500 mm	21352

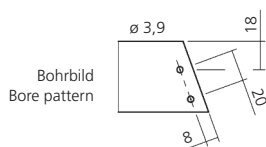
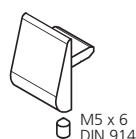
 Intermediate bracket
 without degree

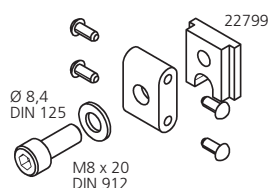
 ohne Zubehör
 without accessories

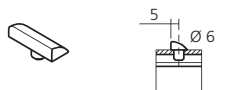
 Trägernase, Aluminium
 Support catch

22982

 Befestigung, Aluminium
 Clamping piece

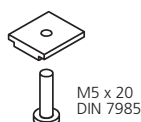
22798

 Glasanschlag, Kunststoff
 Glass stop, plastic

21354

 Glasbodenauflage, Kunststoff
 Support for glass, plastic

51249

 Klemmstück
 Clamping piece

21355